

MEASUREMENT PROTOCOL

VEHICLE DATA

26.03.2022

Number plate:

Brand name: Jaguar

Model: XFR

Version:

Engine:

Mileage: 17328 km

Vin: SAJWA8JC2DMS51682

The measurements done by:

Name and Surname: Marcin Ogiegło

Company: Carfactor

Other data:

MEASURING DEVICE

GL-PRO-SMART

Serial No. 74:D2:85:8C:BD:12

Conclusions and notes

GRAPHIC PRESENTATION OF VARNISH ELEMENT MEASUREMENTS

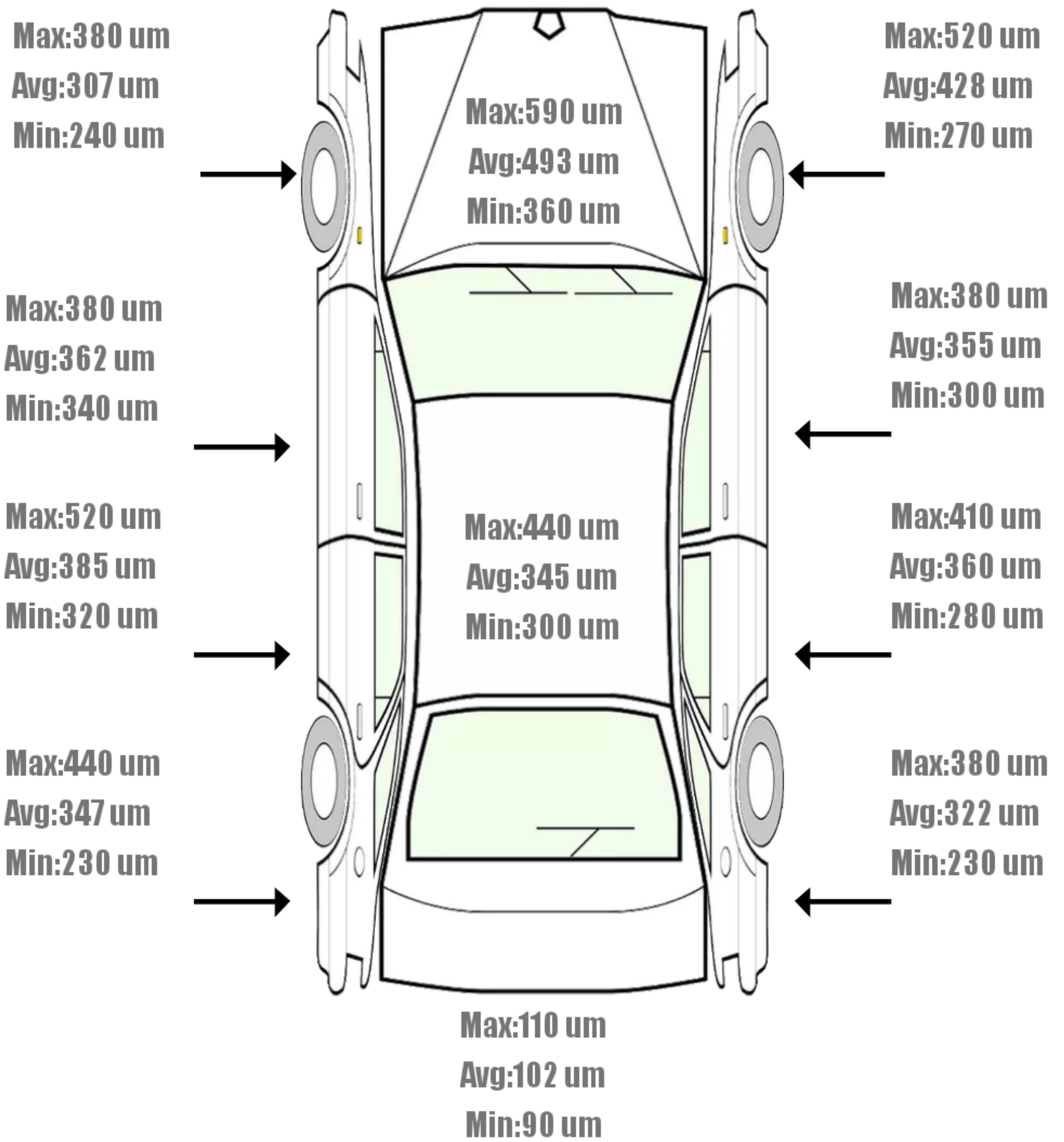

GRAPHIC PRESENTATION OF VARNISH ELEMENT MEASUREMENTS OF THE PILLARS AND THRESHOLD

Left side

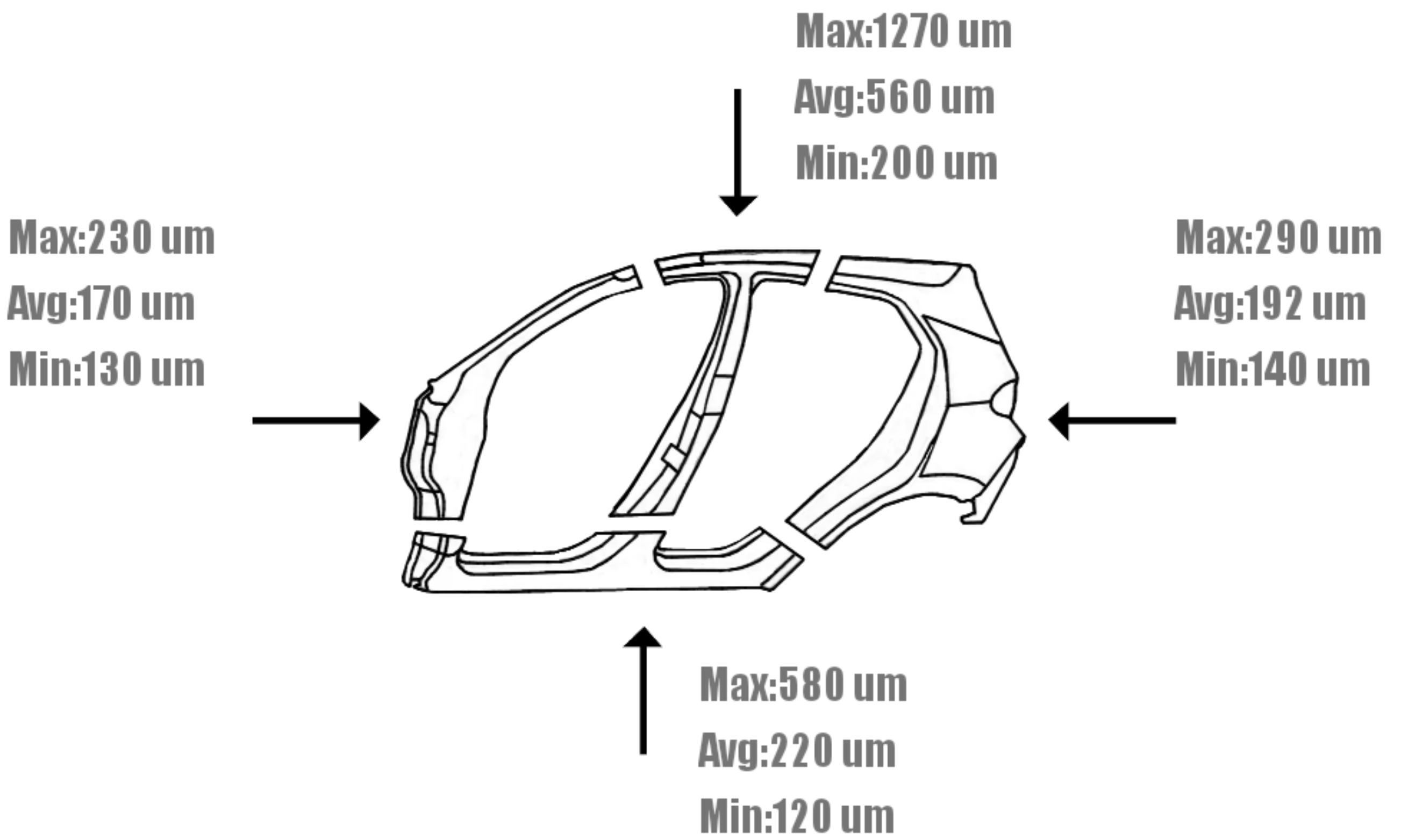

Right side

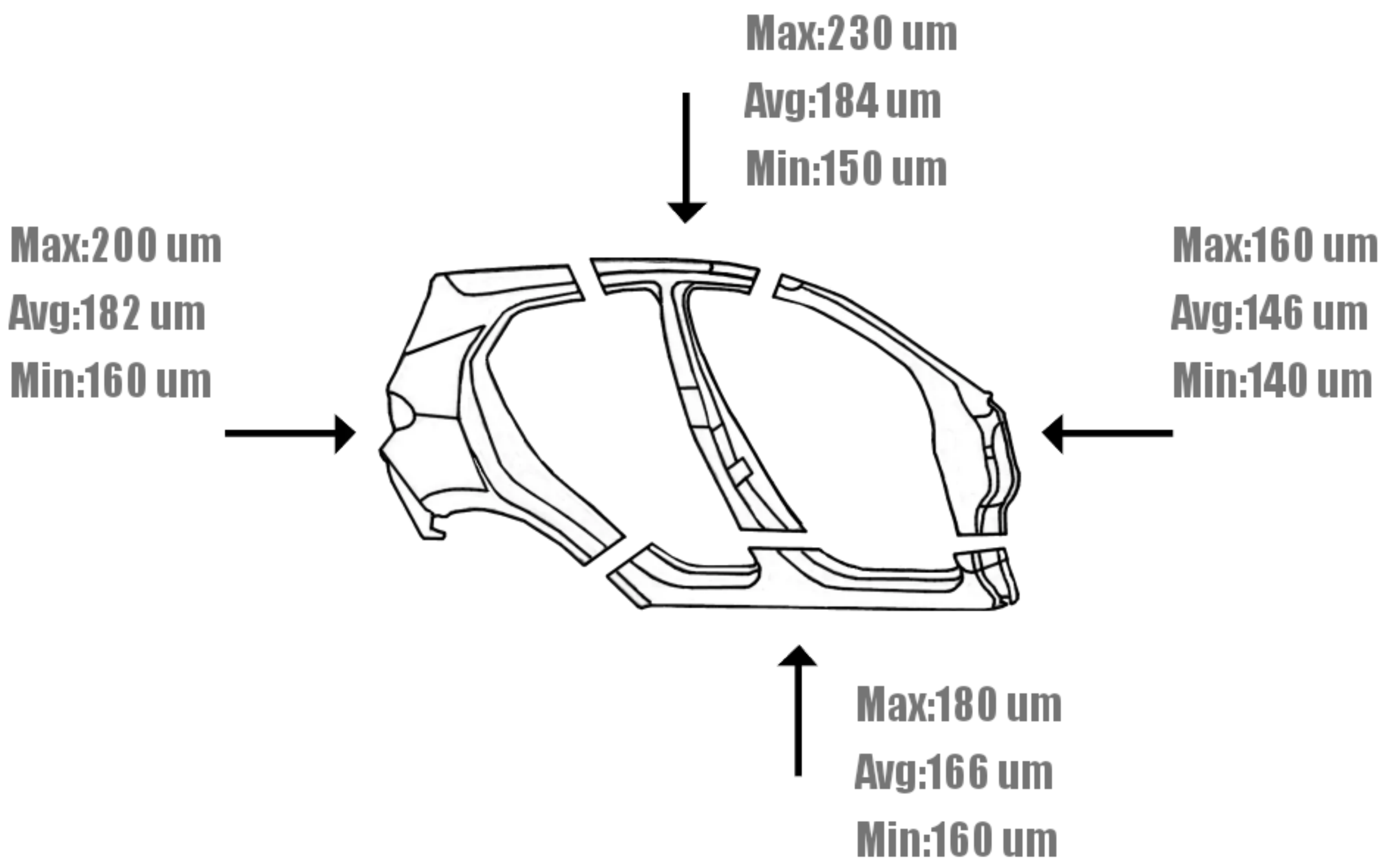

TABULAR PRESENTATION OF VARNISH ELEMENT MEASUREMENTS

Hood

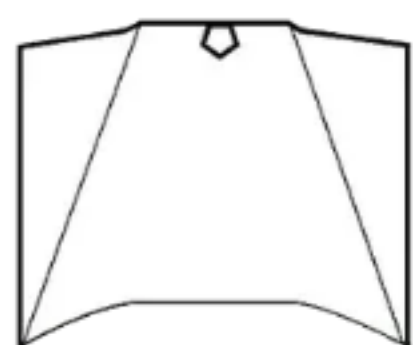

- 1. 360 AL**
- 2. 490 AL**
- 3. 510 AL**
- 4. 590 AL**
- 5. 450 AL**
- 6. 560 AL**

Roof

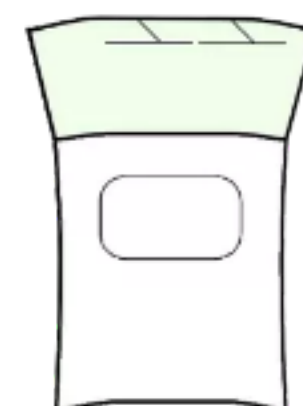

- 1. 440 FE+ZN**
- 2. 300 FE+ZN**
- 3. 340 FE+ZN**
- 4. 390 FE+ZN**
- 5. 300 FE+ZN**
- 6. 300 FE+ZN**

Trunk lid

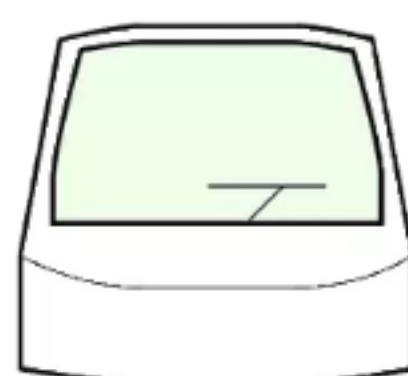

- 1. 90 FE+ZN**
- 2. 100 FE+ZN**
- 3. 110 FE+ZN**
- 4. 110 FE+ZN**
- 5. 100 FE+ZN**

Left, rear fender

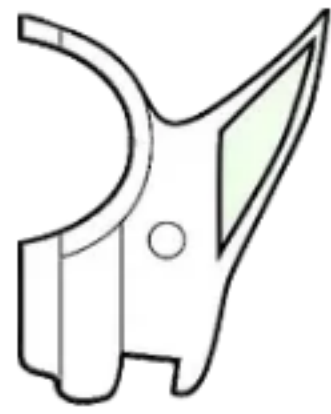

- 1. 350 FE+ZN**
- 2. 230 FE+ZN**
- 3. 270 FE+ZN**
- 4. 320 FE**
- 5. 440 FE**
- 6. 360 FE+ZN**
- 7. 370 FE+ZN**
- 8. 400 FE+ZN**
- 9. 390 FE**

Right, rear fender

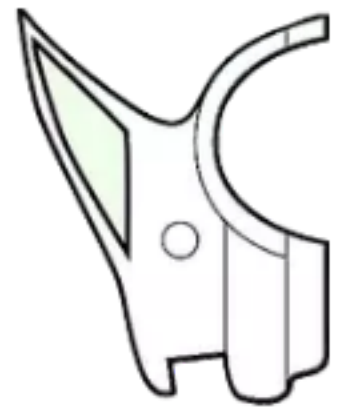

- 1. 380 FE**
- 2. 380 FE+ZN**
- 3. 360 FE+ZN**
- 4. 320 FE+ZN**
- 5. 230 FE+ZN**
- 6. 330 FE+ZN**
- 7. 260 FE+ZN**

Left, front fender

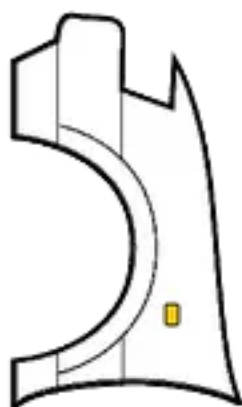

- 1. 240 FE+ZN**
- 2. 360 FE**
- 3. 380 FE**
- 4. 250 FE+ZN**

Right, front fender

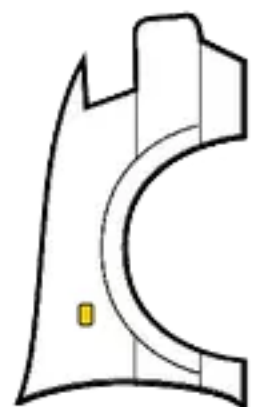

- 1. 440 FE**
- 2. 430 FE+ZN**
- 3. 520 FE**
- 4. 480 FE**
- 5. 270 FE+ZN**

Left, front door



- 1. 360 FE+ZN**
- 2. 340 FE**
- 3. 380 FE+ZN**
- 4. 370 FE+ZN**

Right, front door



- 1. 300 FE**
- 2. 360 FE+ZN**
- 3. 380 FE+ZN**
- 4. 380 FE+ZN**

Left, rear door

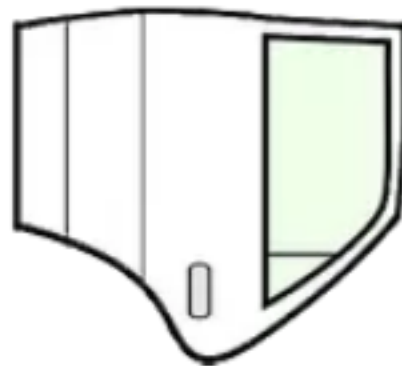

- 1. 370 FE+ZN**
- 2. 320 FE**
- 3. 520 FE**
- 4. 330 FE+ZN**

Right, rear door

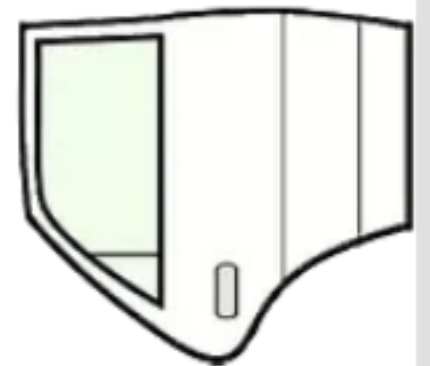

- 1. 280 FE+ZN**
- 2. 410 FE+ZN**
- 3. 390 FE+ZN**

Left, a pillar

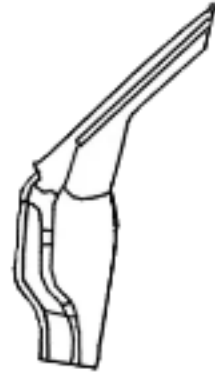

- 1. 130 FE+ZN**
- 2. 230 FE+ZN**
- 3. 150 FE+ZN**

Left, b pillar



- 1. 200 FE+ZN**
- 2. 1270 FE**
- 3. 210 FE**

Left, c pillar



- 1. 190 FE**
- 2. 290 FE+ZN**
- 3. 140 FE+ZN**
- 4. 150 FE**

Left threshold



- 1. 130 FE+ZN**
- 2. 580 FE**
- 3. 180 FE**
- 4. 120 FE+ZN**
- 5. 180 FE**
- 6. 130 FE+ZN**

Right, a pillar

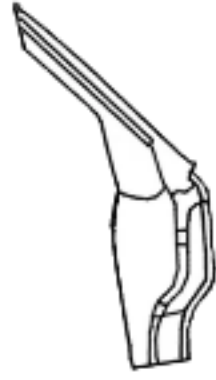

- 1. 140 FE+ZN**
- 2. 160 FE+ZN**
- 3. 140 FE+ZN**

Right, b pillar



- 1. 160 FE**
- 2. 150 FE+ZN**
- 3. 150 FE**
- 4. 230 FE+ZN**
- 5. 230 FE+ZN**

Right, c pillar



- 1. 190 FE**
- 2. 160 FE**
- 3. 180 FE**
- 4. 200 FE**
- 5. 180 FE**

Right threshold

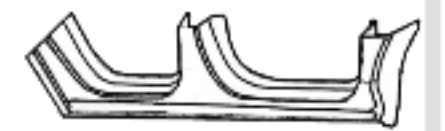

- 1. 160 FE**
- 2. 160 FE**
- 3. 180 FE**